

DUHUI



QUALITY PARTS

HYDRAULIC RELEASE BEARING



TS 16949

Provide quality products and trustworthy services to global auto parts consumers

COMPANY PROFILE



Hangzhou DUHUI Auto Parts Co., Ltd. was established in 2003 and is located in Xiaoshan District Economic Development Zone, Hangzhou City. The company integrates supply chain development, quality management, warehousing, business operations, and other management capabilities, and is built through an information system to provide customers with one-stop services product solutions.



DUHUI has been focusing on automotive bearings for 20+ years, it mainly produces wheel hub, wheel bearing, release bearing, tensioner, etc., covering more than 4,000+ auto parts models, including all mainstream models on the market.

QUALITY CONTROL



We have installed a complete line of international-advanced production equipments and implemented fabrication technology. The equipments include SIGMA numerically controlled lathe Durability Test Machine, etc.

TESTING CENTER



We installed a complete international-advanced testing and examining equipments to ensure the quality of our products. Our Quality Department strictly test each unit according to ISO/TS standards.

INTRODUCTION

Release Bearing:

The release bearing is an important component in the automobile clutch and is usually installed between the clutch and transmission. Its main function is to separate the clutch pressure plate and clutch friction plate when the clutch is disengaged, thereby achieving the separation of the engine and transmission.

The working principle of the release bearing is to realize the connection or disconnection between the automobile engine and the transmission system through the axial movement of the bearing. In operations such as starting, shifting, and parking the car, the release bearing plays a vital role. It can make the car start, shift, and stop smoothly, and it also plays a certain protective role in overloading the car's transmission system.

Automobile Clutch:

Automobile clutches can be divided into mechanical clutches, hydraulic clutches, electromagnetic clutches and pneumatic clutches according to their driving methods.

Hydraulic clutch: A hydraulic clutch transmits clutch operating force through a hydraulic system. Hydraulic clutches are typically lighter and require less operating force because the hydraulic system can provide a greater leverage ratio.

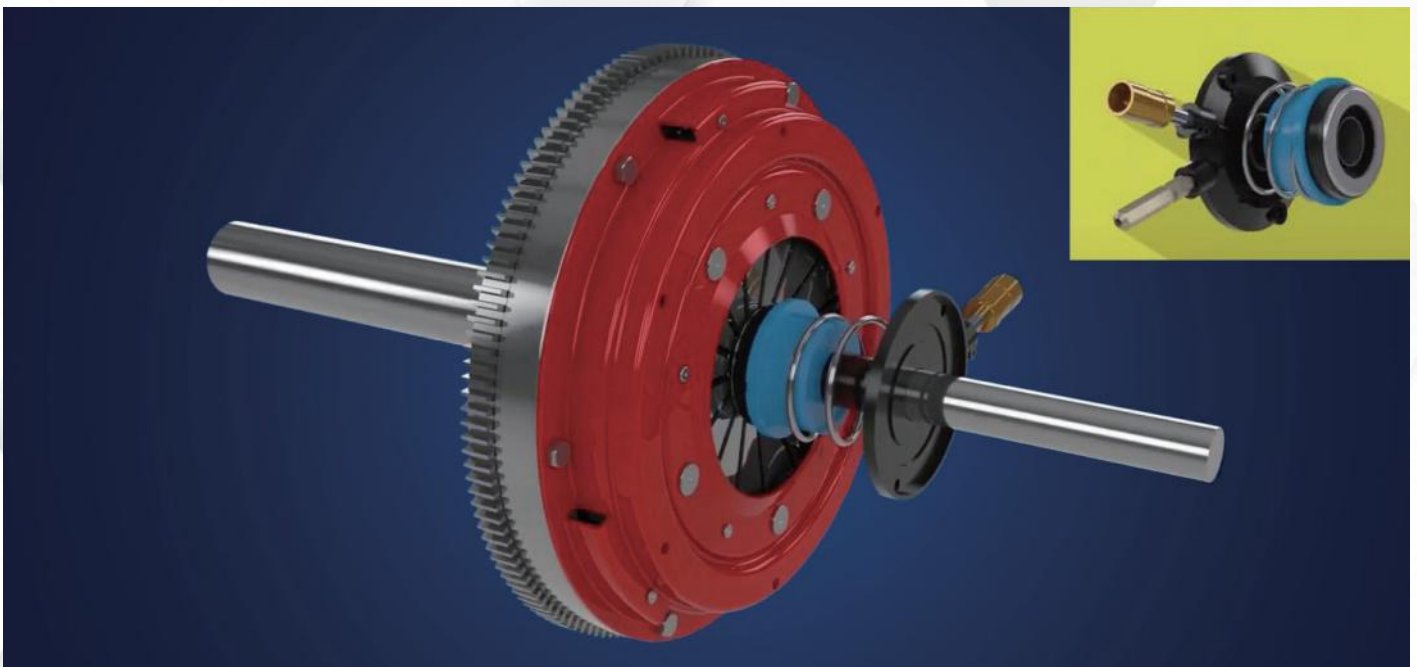

Hydraulic Clutch Release Bearing

The clutch release bearing realizes clutch separation and engagement under the action of fluid pressure.

In a hydraulic clutch system, the release bearing is usually located above or inside the piston of the clutch cylinder, adjacent to the pressure plate. The function of this bearing is similar to the release bearing in a mechanical clutch, which is used to separate the connection between the pressure plate and the engine.

BASIC STRUCTURE

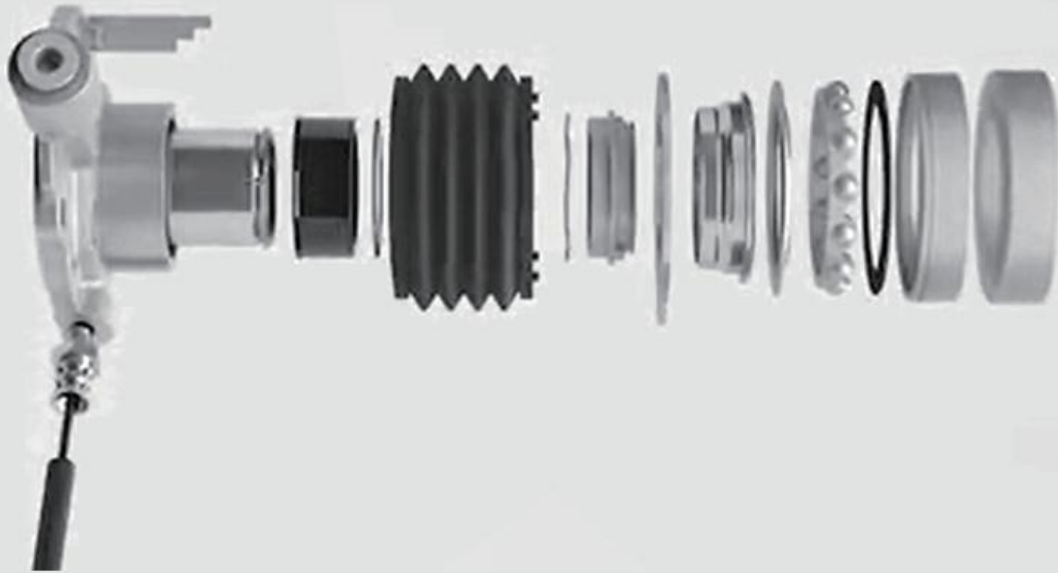

Hydraulic release bearings rely more on the pressure generated by the liquid medium to achieve bearing separation.

Inner and outer rings : The inner and outer rings are usually made of metal and are used to support and position the rolling elements in the bearing.

Rolling elements: Usually needle rollers, balls or rollers, etc., used to roll between the inner and outer rings to reduce friction.

Hydraulic chamber: The hydraulic chamber is one of the core components of the hydraulic release bearing, which is filled with liquid medium (such as hydraulic oil). When the liquid medium is under pressure, a pressure area is formed inside the bearing, which separates the rolling elements from the raceway, thereby reducing friction and wear.

Sealing device: Used to keep the liquid in the hydraulic chamber from leaking and prevent external contaminants from entering the inside of the bearing.

WORKING PRINCIPLE

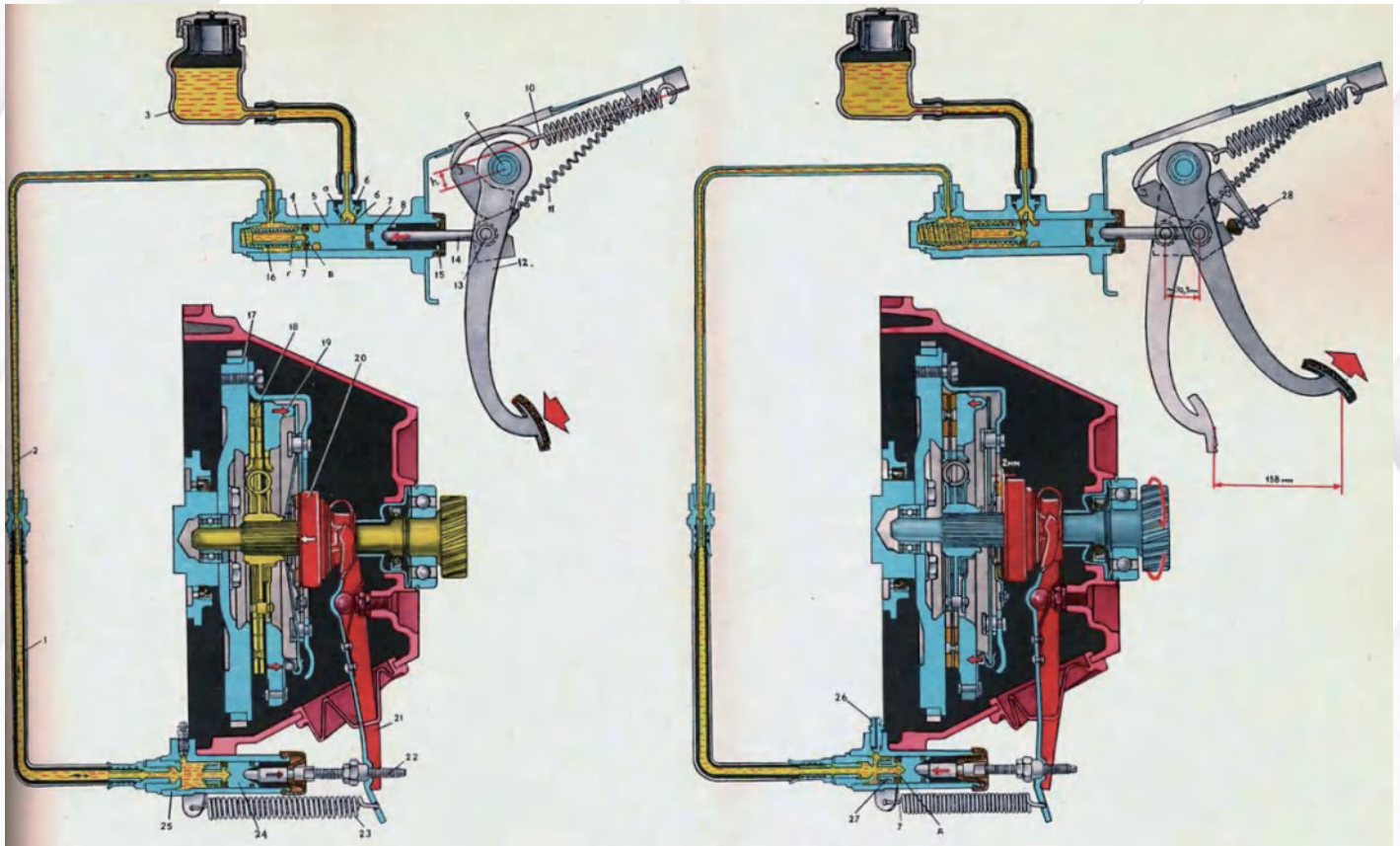

The working principle of the hydraulic release bearing is to transmit pressure and control the separation and combination of the clutch through the hydraulic system. When the clutch pedal is depressed, the hydraulic system generates oil pressure, which transmits pressure through the hydraulic oil and pushes the piston to move, causing the pressure plate to separate or combine with the engine crankshaft.

Hydraulic release bearings have the advantages of fast response, high precision, and light operation, but they require regular maintenance and upkeep to ensure their normal operation.

Connected state: When the hydraulic clutch is in the connected state, the hydraulic system applies hydraulic pressure to the clutch hydraulic cylinder, which causes the piston in the hydraulic cylinder to apply force to the pressure plate, connecting the pressure plate and the flywheel together, thereby realizing the connection between the engine and the transmission.

Disengagement state: When the driver needs to separate the engine and transmission, the hydraulic system will reduce or interrupt the hydraulic pressure applied to the clutch hydraulic cylinder. This causes the piston in the clutch hydraulic cylinder to reduce the force or move to a position that separates the pressure plate from the engine and stops power transmission.



DIRECTORY

ALFA ROMEO	1
AUDI	2
BENZ	3
BUICK	4
CASE IH	5
CHERY	6
CHRYSLER	7
CITROEN	8
CHEVROLET	9
DACIA	11
FIAT	12
FORD	13
GEELY	17
GREAT WALL	18
HYUNDAI	19
JAC	20
JAGUAR	21

DIRECTORY

JEEP	22
JOHN DEERE	23
MAZDA	24
MG	25
MITSUBISHI	26
NISSAN	27
OPEL	29
PONTIAC	30
RENAULT	31
ROWIE	32
SAAB	33
SSANGYONG	34
SUZUKI	35
TOYOTA	36
VOLVO	37
VW	38
ZOTYE	39

PHOTO	PART NO.	APPLICATION	YEAR
	55190965 510007410	ALFA ROMEO 147 (937_) 1.6 16V T.Spark (937.Axa1A, 937.Axb1A, 937.Bxb1A)	2001-2010
	55190965	ALFA ROMEO 147 (937_) 1.6 16V T.Spark (937.AXA1A, 937.AXB1A, 937.BXB1A)	2001-2010
	600184 ZA34048.3.13182 510021310 55563645	ALFA ROMEO 159 (939_) 1.8 TBi (939.AXN1B)	2009-2012
	55243921	ALFA ROMEO Mito (955_) 1.6 JTDM (955AXC1B)	2008-2015
	510013910	ALFA ROMEO GT (937_) 1.8 TS (937CXR1A)	2003-2010
	204189 510 0093 10 ZA3202671 3182 600 161 55207502 204183	ALFA ROMEO 166 (936_) 2.4 JTD (936AXC00)	2006-2007
	5679344 510009610 ZA34036A1 3182600130 24422064 93186759	ALFA ROMEO 159 (939_) 3.2 Jts Q4 (939Axb1B, 939Axb22)	2005-2011



PHOTO	PART NO.	APPLICATION	YEAR
	BSB-26 GM922514762 GM2426418	AUDI A3	2002
	1214516 02M141671A 0A5141671 804529 510007110 3182997901	AUDI A1 (8X1, 8XK) 1.4 TSI	2014-2018
	0A5 141 671 F 510 0177 10 ZA29015.7.1 3182 600 197	AUDI A1 (8X1, 8XK) S1 Quattro	2014-2018

DUHUI



PHOTO	PART NO.	APPLICATION	YEAR
	000254 2508 804528 510003510 ZA3608.3.2	BENZ C-Class (W204) C 180 CDI (204.000)	2010-2014
	22503015 22507615 22502415 22502815	BENZ Atego 2 923, 923 L, 924, 924 L	2004-
	0022505215 510005710 ZA5109.3.2 3182600101	BENZ Atego 1014 K	1998-2004
	0022502915 510002722 ZA5108.3.2 3182998501	BENZ Vario Dump Truck 813 D, 814 D (670.331, 670.332)	1996-2013
	0022501815 510000910 3182998701 ZA2602A1	BENZ B-Class Sports Tourer (W245) B 200 (245.233)	2005-2011
	3182998501	BENZ Tourino (O 510) (10.2003-)	1998-2004
	0002541308 0002541808 A0002541308 A0002541808	BENZ Vito Bus (W638) 108 CDI 2.2 (638.194)	1999-2003
	510005420	BENZ	

PHOTO	PART NO.	APPLICATION	YEAR
	510026010	BUICK Excelle 1.5	2008-

DUHUI

PHOTO	PART NO.	APPLICATION	YEAR
	3182001103 510002120 3182001003	CASE IH Maxxum 110, 120	2011-
	6852500015 3182001307 47134440 F-237380 510001910	CASE IH Maxxum 110, 120	2011-
	AL66088 510002110 3182001105	CASE IH Maxxum 110, 120	2011-



DUHUI

PHOTO	PART NO.	APPLICATION	YEAR
	519MHA-1602501	CHERY A3 Hatchback 1.6	2009-2014
	519MHA-1602501	CHERY A3 Hatchback 1.6	2009-2014

DUHUI

PHOTO	PART NO.	APPLICATION	YEAR
	4668897AB	CHRYSLER Pt Cruiser (PL) Gt 2.4	2003-2010



DUHUI

PHOTO	PART NO.	APPLICATION	YEAR
	510012910 ZA24016.7.1	CITROEN C4 Coupe (LA_) 1.6 Thp	2008-2011
	510015910 ZA31018A1 3182600186 204182	CITROEN C6 (TD_) 2.2 HDi	2006-2012

DUHUI

PHOTO	PART NO.	APPLICATION	YEAR
	ZA348191A	CHEVROLET Aveo 1.4L	2011-2015
	3182600158 96961189 4817538	CHEVROLET Captive (C100, C140) 3.0 4WD	2010-2018
	510 0175 10 ZA34055.3.1 3182 600 194	CHEVROLET Cruze (J300) 1.6, 1.8	2009-
	22602575 ZA3407B1 510 0051 20	CHEVROLET Cavalli Convertible 2.2	1998-2000
	ZA34056.3.1 96829734 3182600193	CHEVROLET Cruze Sedan 2.0 CDI	2009-
	SB1716 510004110 8157055630 88934649	CHEVROLET Silverado 1500 Standard Cab Pickup 4.3	2007-2013
	15060929 510008710	CHEVROLET Silverado 1500 Standard Cab Pickup 4.3	2007-2013
	96832585 510017510 ZA3405531 3182600194	CHEVROLET Cruze Hatchback (J305) 1.7 D	2012-2015
	89059282	CHEVROLET Corvette 5.7I V8	2002-2004

PHOTO	PART NO.	APPLICATION	YEAR
	12582666 3182654121 ZA34020B1	CHEVROLET Hhr 2.4	2007-2011
	24248706 ZA34066.3.1 24248706	CHEVROLET Captiva (C100, C140) 2.2 D 4wd	2011-
	15019756 za4501a1	CHEVROLET Silverado 2500 6.6l V8 Diesel Turbocharged	2002-2006
	25185077 ZA34819.1 96890028	CHEVROLET Aveo Saloon (T300) 1.2 Lpg	2012-2015
	24235621	CHEVROLET Silverado 1500 4.3l V6	2003-2005
	5679040 24422066	CHEVROLET Cruze (J300) 1.4	2013-

PHOTO	PART NO.	APPLICATION	YEAR
	F050-1601308 306201586R	DACIA DUSTER (HS_) 1.5 dCi (HSAJ)	2010-2018
	82 00 855 816 510009010	DACIA Rogan Touring 1.5 dCi (KS0K)	2007-





DUHUI

PHOTO	PART NO.	APPLICATION	YEAR
	24424957 5679304 5679332 510005310 23820-63JA0 ZA3103B2	FIAT Croma (194_) 1.8 16V (194AXG1A)	2005-2011
	3182507 115ZA31028.3.1 510017010 23820-79J00	FIAT Sedici (189_) 1.6 16V	2006-2014
	510010810 ZA2702.7.1 2324A077	FIAT Fullback Pickup (502_, 503_) 2.4 D 4x4 (KT0T)	2016-
	55231613	FIAT Doblo Platform/Chassis (263_) 1.3 D Multijet	2010-
	55209138 510 0142 10 3182 600 125 ZA2401041 55180328	FIAT Stilo (192), Idea, Ritmo Iii (198)	2005-2008
	804521 834005	FIAT Adil MPV 1.9 JTD	2004-
	8201035313 ZA31042.3.6	FIAT Talento Bus (296_) 2.0 Ecojet	2019-
	510007419 VKCH4896	FIAT Siena (178_, 172_) 1.8 Hlx Rst Ii Flex (17241c1)	2006-2010
	55209138 510014210 3182600125 ZA2401041 55180328	FIAT Stylish Hatchback/Hatchback(192)	2001-2010

PHOTO	PART NO.	APPLICATION	YEAR
	F9SZ-7A564-A 37897(SIA) F1TZ7A564A 619022	FORD Truck-Ranger	1988-1991
	F37A-7A543-CB F-126893 VKCH151103 510004610	FORD Explorer	2001-2006
	F1TA-7A508-AA F1TZ-7A564-A F4SC-7C522-BA 510004510	FORD Ranger 3.0	1990-1996
	360016 126893 510004610	FORD Explorer	1997-2000
	XS417A564EA 1075776 510001110	FORD Courier Pickup 1.6	2001-2011
	YL5Z-7A548-AA 510002610 510005910	FORD Ranger (ET) 4.0	2006-2011
	1075778 XS417A564 AB3182998301 510002310	FORD Tourneo Connect MPV	2002-2013
	3182600110 510002311	FORD Transit Bus (FD__, FB__, FS__, FZ__, FC__) 2.2 TDCi	2006-2014
	1478806 94ZT7A564AA F5RZ7A508B 006141165C 510000110	FORD Galaxy I (WGR) 2.3 16V	2001-2006
	2S657A564AA 7S657A564AA 804543 510001111	FORD Courier Pickup 1.6	2001-2011
	3M51-7A564-EA 510014010 804573 ZA31012.4.7	FORD C-Max II (DXA/CB7, DXA/CEU) 2.0 TDCi	2010-2019

PHOTO	PART NO.	APPLICATION	YEAR
	4C11-7C559-AC 1675978 510009210 ZA2808.4.1 3182600157	FORD Ranger (TKE)	2011-
	2S617A564CA 1212061 1474323 510005810	FORD B-Max (JK) 1.0 EcoBoost	2016-
	3M517A564AG 1457641 510013010 804572 ZA2802.4.7 3182600148	FORD Focus II (DA_, HCP, DP) 1.8 Flexifuel	2006-2012
	1232035 3M51-7A564-BE JC01-16-530C 510012410 ZA32011.4.7	FORD Focus II (DA_, HCP, DP) 1.6 TDCi	2004-2012
	CC11-7A564-BB ZA34075.3.1	FORD Transit Bus (FD_, FB_, FS_, FZ_, FC_) 2.2 TDCi	2006-2014
	3M517A564AF 1230915 510 0154 10 ZA2802.4.6	FORD Focus C-Max	2003-2007
	510012210 3182998801 804506	FORD Transit Van (FA_) 2.0 DI (FAE_, FAF_, FAG_)	2000-2006
	JB3R-7A564-AA	FORD Ranger (TKE) 2.0 EcoBlue 4x4	2019-
	5L8Z-7A508-AA	FORD Escape	2005-2008
	ZA36823.1	FORD Mustang	
	510 0102 10	FORD Focus II Sedan 2.5 RS	2009-2011

PHOTO	PART NO.	APPLICATION	YEAR
	ZA3407632	FORD Tourneo Custom V362 Bus (F3) 2.2 TDCi	2012-2015
	F1TA7A508AA D151005 510004510	FORD Ranger 3.0	1990-1996
	E3TZ7600C 510005910 510002610	FORD Ranger 3.0	1990-1997
	3182998601 1E0016540A XS417A564EA ZA2802A1 510001110	FORD Focus Wagon (DNW) 1.4 16V	1999-2004
	510006510 2S657A564AA	FORD Fiesta V (JH_, JD_) 1.25 16V	2003-2008
	XS417A564AC 3182998301 ZA3209A1 510002310	FORD Focus Hatchback/Hatchback (DAW, DBW) 1.8 16V	1998-2004
	4543504 510009210 ZA280841 3182600157	FORD Ranger (TKE) 2.2 TDCi	2011-
	8C117A564AB 510013210 3182600183 ZA3409271	FORD Transit Van (Fa_) 2.2 Tdci	2008-2014
	1251311 510012510 ZA310932 3182600149 C2S43866	FORD Mondeo Iii Turnier (Bwy) 2.2 Tdci	2004-2007
	510014090 3182600147 ZA3101244 30651915 1405590	FORD Kuga Ii (Dm2) 2.0 Tdci 4x4	2014-2019
	YL5Z7A508AA ZZL116510	FORD Ranger (Er, Eq, R_) 2.3	2001-2005

PHOTO	PART NO.	APPLICATION	YEAR
	1368665 510010210 ZA310831 3182600136	FORD Focus li (Da_, Hcp, Dp) 2.5 Rs	2009-2011
	5R3Z7A508AA BRG0159 D151159	FORD Mustang 4.0l V6	2005-2010
	1727159 CC11-7A564-BB	FORD Transit V363 Platform/Chassis (Fed, Ffd) 2.2 Tdci Rwd	2013-2018
	510021110 5021GH884 L050210GH884	FORD C-Max (Dm2) 1.6 Tdci	2007-2010
	ZA34011A1 3182600173 5L847A508AA	FORD Maverick 2.3 16v	2004-2007





DUHUI

PHOTO	PART NO.	APPLICATION	YEAR
	FE-5A/7A	GEELY Emgrand Gs	



DUHUI

PHOTO	PART NO.	APPLICATION	YEAR
	1601030XCM52 B	GREAT WALL Hover H6 1.5 4wd	2014-

DUHUI

PHOTO	PART NO.	APPLICATION	YEAR
	3182600159 4142124350 4142124300	HYUNDAI Santa Fé Iii (Dm, Dma) 2.4	2012-2015
	ZA34819B 10026355	HYUNDAI Zotye T600 1.5t	
	4142138000 ZA32028.7.1 3182 600 192 804561	HYUNDAI Genesis Coupe 2.0 T	2008-2012
	4142138500 ZA3202771 3182600160	HYUNDAI Santa Fe (Cm)	2005-2012

DUHUI

PHOTO	PART NO.	APPLICATION	YEAR
	BB41392	JAC S5, M5 1.8T/2.0T	
	BB40530	JAC	
	BB40530S35	JAC Rein	

DUHUI

PHOTO	PART NO.	APPLICATION	YEAR
	1251311 3S717A564BB 510012510 ZA3109.3.2	JAGUAR X-Type I (X400) 2.2 D	2007-2009

DUHUI

PHOTO	PART NO.	APPLICATION	YEAR
	510001310 3182600115 ZA3504A1 619003	JEEP Cherokee (Xj) 2.5 l 4x4	1991-2001
	83503384 ZA3504A1 619001	JEEP Cherokee (Xj) 4.0 l	1991-2001
	LSC270 SB60054 619009	JEEP Cherokee (Xj) 2.5 l 4x4	1991-2001
	510006810 SB60054 619004	JEEP Cherokee (Xj) 4.0 l	1991-2001
	N8076 619008	JEEP Wrangler I (Yj, Sj_) 4.0	1991-1996
	619007 N8077	JEEP Cj5 - Cj8 4.2	1972-1987
	05273431AB 05273431AA ZA2401771 3182600154 510010510	JEEP Patriot (Mk74) 2.2 Crd 4x4	2011-2017

PHOTO	PART NO.	APPLICATION	YEAR
	510002010	JOHN Deere	

DUHUI

PHOTO	PART NO.	APPLICATION	YEAR
	DK4917ZX1A 510005810 3182600112 ZA2802410 1474323	MAZDA 2 (Dy) 1.3 L (Dy3w)	2003-2007



DUHUI

PHOTO	PART NO.	APPLICATION	YEAR
	ZA3003.7.1 510008410	MG ZT 1.8 T 16V	2003-2005

DUHUI

PHOTO	PART NO.	APPLICATION	YEAR
	MN168395	mitsubishi Lancer 2.0L L4	2002-2003
	ME523197	MITSUBISHI Fuso	
	ME539936	MITSUBISHI Fuso	
	ME539937	MITSUBISHI Fuso	
	ME540224 MK525698	MITSUBISHI Fuso	
	2324A081A	MITSUBISHI Fuso Canter	2012-
	MK265589 ME540228	MITSUBISHI Fuso Canter	2012-
	MK525698 ME540224	MITSUBISHI Fuso Canter	2012-

PHOTO	PART NO.	APPLICATION	YEAR
	30570-00QAA 93160102 8200124021 510002511 ZA2701A1 3182998101	NISSAN Interstar Bus (X70) dCi 100	2006-2011
	30570-00QAA 93160102 8200124021 510002511 ZA2701A1 3182998101	NISSAN Interstar Bus (X70) dCi 100	2006-2011
	30570-00QAB 510022510 510011610 3182600168	NISSAN Interstar Bus (X70) dCi 120	2006-2011
	8200046103 30620-00Q0A 30620-00QAB 804527 510009710 3182600129	NISSAN Note MPV (E11)	2005-2012
	804526 3182600128 510010010 8200341798 30620-AE800	NISSAN Primera (P12) 1.9 dCi	2003-2007
	ZA31042.3.6 804585	NISSAN Interstar Bus (X70) dCi 100	2006-2011
	32150-00QAC 306206299R 306A0-JA60B 3182 600 138 510 0164 10	NISSAN Note MPV (E11) 1.5 dCi	2008-2012
	3182654126 306A1-JK40A	NISSAN Fairlady Z 3.5	2006-2008
	3182600129 ZA300741 510009710 510008530 30620BN700	NISSAN Qashqai / Qashqai +2 I (J10, Nj10, Jj10e) 1.6	2010-2013
	4432435 510011610 3182600162 ZA260741 3057000QAB 8200846744	NISSAN Interstar Bus (X70) Dci 100	2006-2011
	3215000QAC 510010010 3182600138 ZA300841 8200213679	NISSAN Primera Hatchback (P12) 1.9 Dci	2003-2007



PHOTO	PART NO.	APPLICATION	YEAR
	30620AE800 510008830 8200341798	NISSAN Pulsar Hatchback (C13) 1.5 Dci	2014-2019
	306A1JK40D 3182654126	NISSAN 370 Z Coupe (Z34)	2009-

DUHUI

PHOTO	PART NO.	APPLICATION	YEAR
	90523765 KT113 B-S002 621 242409 24424957 679344	OPEL AStrA G Classic Caravan (F35) 1.4 (F35)	2007-2009
		OPEL	
	9126238 ZA31013A2 2422061 510006310	OPEL Corsa D Van (S07)	2006-2014
	679346 90522729 ZA3403A1 510000210	OPEL AStrA G Saloon (T98) 2.0 16V (F69)	1998-2005
	510007310 5679304 24422061	OPEL AStrA G Classic Caravan (F35) 1.4 (F35)	2007-2009
	55583068	OPEL AStrA K 1.4 Turbo (68)	2015-
	3182600205 804581 55232693 NCS165	OPEL Combo Box Body / Estate (X12)	2012-

PHOTO	PART NO.	APPLICATION	YEAR
	1741182 92227219	PONTIAC G8	2009

DUHUI

PHOTO	PART NO.	APPLICATION	YEAR
	510009010 8200046102 73503563	RENAULT Clio III (BR0/1, CR0/1) 1.5 dCi	2010-2014
	8200764612 CSC023 3182600121 510009810	RENAULT Clio III Grandtour (KR0/1_) 1.5 dCi	2007-2012
	510009810	RENAULT Kangoo MPV (KC0/1_) 1.6 16V	2001-

DUHUI

PHOTO	PART NO.	APPLICATION	YEAR
	BB 40530S35	ROWIE W5	



DUHUI

PHOTO	PART NO.	APPLICATION	YEAR
	4776308	SAAB 900 Generation Convertible	1985-1994
	5160023 729368	SAAB	
	8781130	SAAB 9000 Four-Door Sedan	1985-1998

DUHUI

PHOTO	PART NO.	APPLICATION	YEAR
	804582 30360-21301	SSANGYONG Kyron 2.7 Xdi 4x4	2006-2014
	3036021100 3182600180	SSANGYONG Actyon	2005-

DUHUI

PHOTO	PART NO.	APPLICATION	YEAR
	23820-78M00	SUZUKI	
	23820-64J00 ZA34023A1 3182 600 177 510 0165 10	SUZUKI Grand Vitara II (JT, TE, TD) 1.6 All-wheel Drive (JB416)	2005-2015

DUHUI





PHOTO	PART NO.	APPLICATION	YEAR
	510013310 31400-59015	TOYOTA Auris (E15_) 1.6 (ZRE151_)	2007-2012
	HT-10896	TOYOTA	
	000 254 29 08 510 0133 10 ZA36015.3.2 804548	TOYOTA Auris (E15_) 1.33 Dual-VVTi (NRE150_)	2009-2012
	3140039005 3140039006	TOYOTA Rav4 Iii Off-Road (Xa30) 2.0 (Zsa35_)	2008-2013
	3140059005 510013310 ZA3105371 3182600175	TOYOTA Auris (e15_)	2006-2012
	3140079005 510013410 ZA3105271 3182600176	TOYOTA Iq (j1_)	2008-





PHOTO	PART NO.	APPLICATION	YEAR
	9463681 510 0049 10 3182 998 201 ZA2904C1	VOLVO S80 I (184) 2.9	1998-2006
	510 0010 10	VOLVO C70 I Convertible (873) 2.0	1998-2005
	8689498 510012410 ZA3201147 3182600150 1418659	VOLVO C30 (533) 2.0 Flexfuel	2010-2012
	MW6900012 510001010 3182998702 ZA290331 9181322 7439181322	VOLVO C70 I Convertible (873) 2.0 T	2000-2005
	21465235 510016610 6482000087 7421465238	VOLVO Fh16 li Fh 16/700	2012-
	8675052 510010310 3182600135 ZA3107A1	VOLVO V50	2003-2012
	8636105 510011210 3182600139 ZA290732	VOLVO XC90	2002-2015
	6482000171 510017110 21459182	VOLVO Fh16 Truck	1993-

PHOTO	PART NO.	APPLICATION	YEAR
	ZA36052.3.4	VW Amarok (2HA, 2HB, S1B, S6B, S7A, S7B) 2.0 BiTDI	2010-2012
	510 0016 10 02F 141 671 B	VW Transporter IV box truck (70XA) 2.5 TDI	1995-2003
	510001610 ZA2803A1 3182998401 02F141671B	VW Transporter IV Truck (70XD)	1990-2003

DUHUI

PHOTO	PART NO.	APPLICATION	YEAR
	ZA34079.3.1	ZOTYE T600 2.0T	

DUHUI

DUHUI

HANGZHOU DUHUI AUTOMOTIVE PARTS CO.,LTD

Add:Economic Development Zone, Xiaoshan District ,Hangzhou,China.

Tel:+86-571-87750727

Website: www.dhautoparts.com

E-mail: market@dh-auto.cn

Provide quality products and trustworthy services to
global auto parts consumers



TS 16949